



GO-ÉLAN
Creating new ways to play

GO-HOP SERIES

5 to 12 years

RAS-503-01

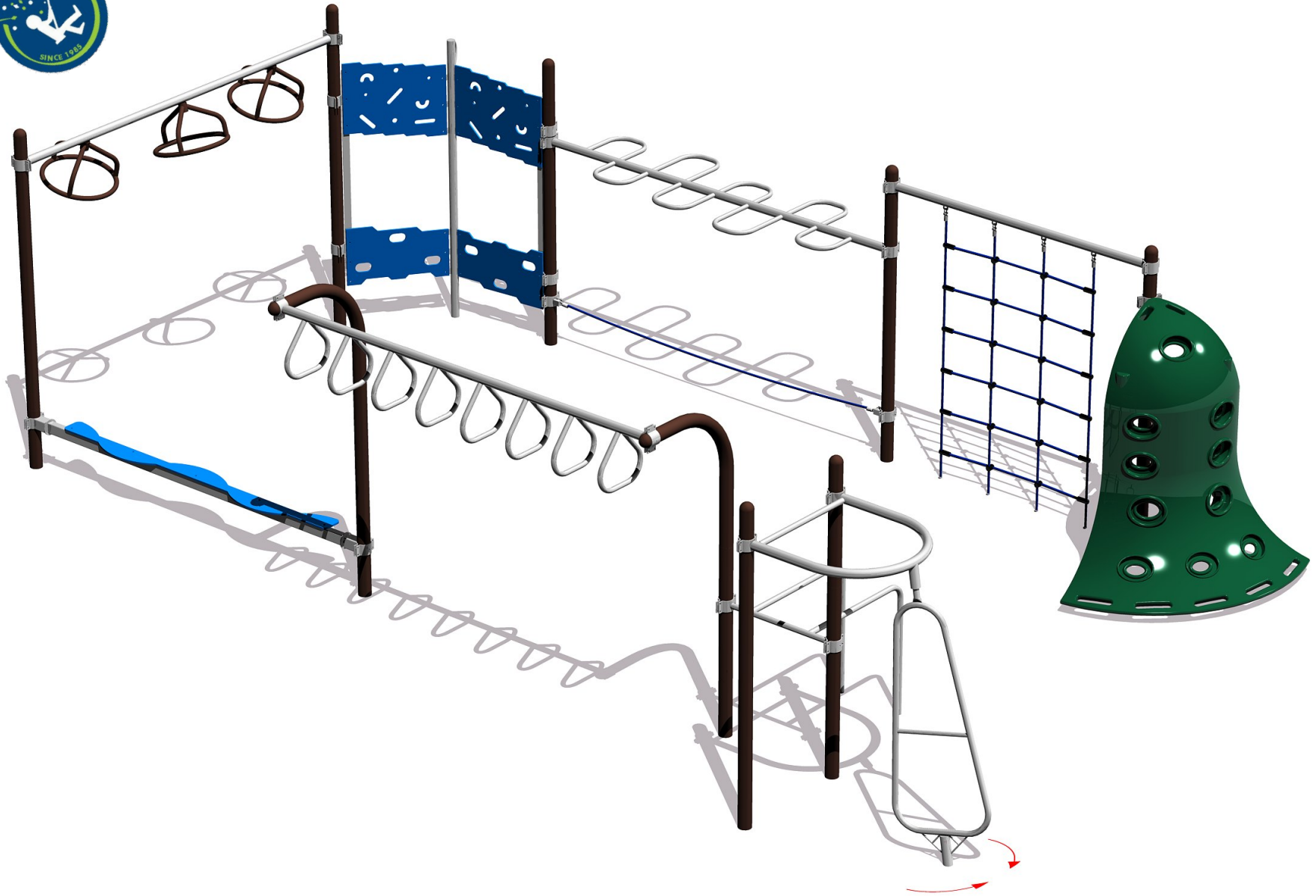

ALUMINUM AND STEEL



DECK

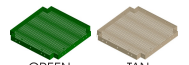

ROTOMOLDED POLYETHYLENE



POLYETHYLENE HD





GO-ÉLAN
Creating new ways to play

GO-HOP SERIES

5 to 12 years

RAS-503-01



ALUMINUM AND STEEL



DECK

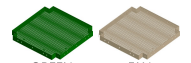

ROTOMOLDED POLYETHYLENE



POLYETHYLENE HD



GO-HOP

CHILD CAPACITY : 23
 EQUIPMENT SIZE : 29' X 18' [8,9m X 5,5m]
 PLAY AREA : 41' X 30' [12,5m X 9,2m]
 FALL HEIGHT : 84" [214cm]

RM-22-89
THE SPINSTER

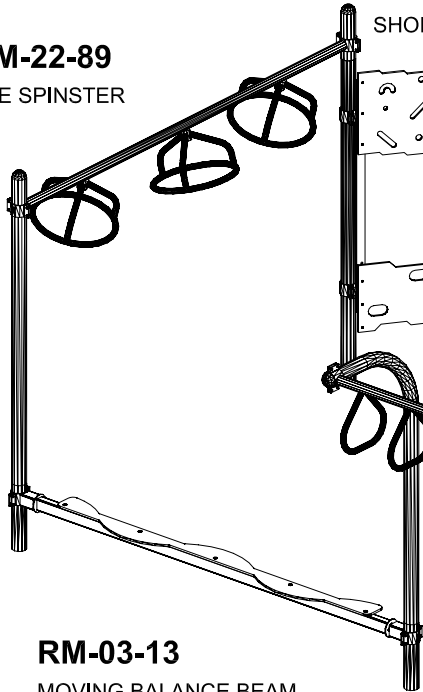

RM-03-13
MOVING BALANCE BEAM

RM-47-70
SHORT CLIMBING WALL

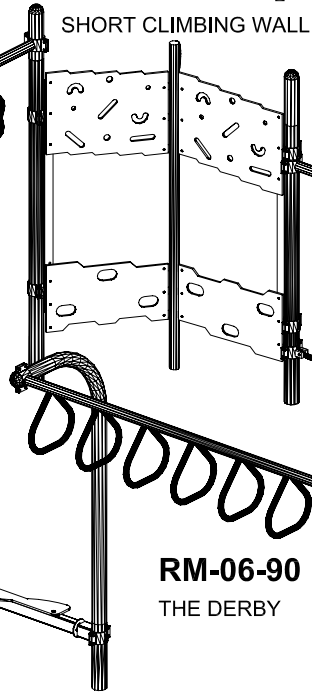

RM-06-90
THE DERBY

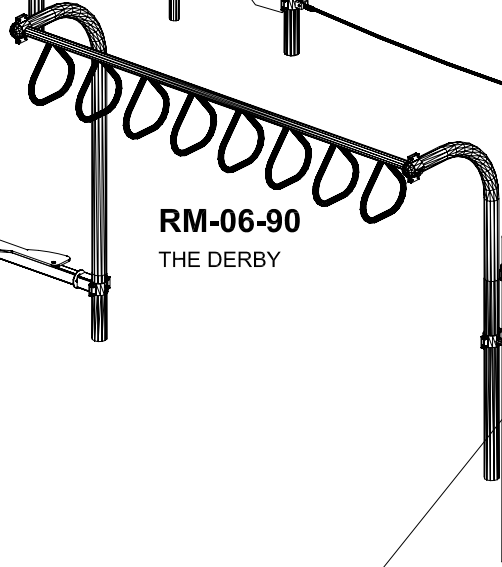

RM-38-38
PARALLEL BARS

RM-07-62
SEA-SNAKE

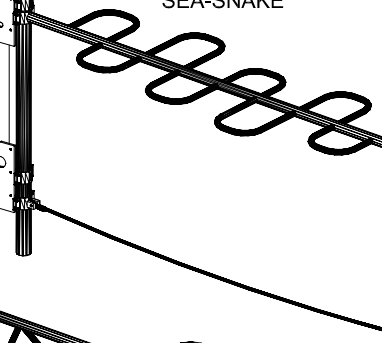

RM-35-80
VERTICAL CABLE NET

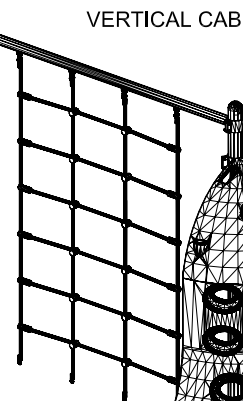

RM-46-71
THE SOLO

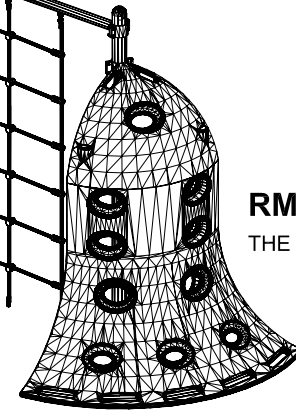

RM-39-75
THE MIXER

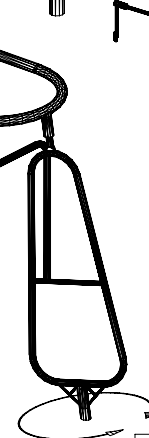

Galvanized steel post 3 1/2"Ø in diameter recovered by powder coating and injection moulded aluminium cap.
 All galvanized steel tubing recovered with powder coating.
 Torx tamper proof stainless steel hardware.

drawing number		
RAS-503		
drawing name		
GO-HOP		
3D VIEW		
date	scale	drawn by
11/09/21	NONE	D. Desilets eng.
ck. by		
APPEARANCE MAY VARY LIGHTLY FROM DRAWING		 <small>630, boul. Bécancour Bécancour (Québec) Canada G9H 3S7 phone: 819.298.3431 Fax: 819.298.2299 www.goelan.com</small>

GO-HOP

CHILD CAPACITY : 23
 EQUIPMENT SIZE : 29' X 18' [8,9m X 5,5m]
 PLAY AREA : 41' X 30' [12,5m X 9,2m]
 FALL HEIGHT : 84"[214cm]

RM-39-75
THE MIXER

RM-06-90
THE DERBY

RM-38-38
PARALLEL BARS

RM-22-89
THE SPINSTER

RM-46-71
THE SOLO

RM-35-80
VERTICAL CABLE NET

RM-07-62
SEA-SNAKE

RM-03-13
MOVING BALANCE BEAM

RM-47-70
SHORT CLIMBING WALL

Galvanized steel post 3 1/2"Ø in diameter recovered by powder coating and injection moulded aluminium cap.
 All galvanized steel tubing recovered with powder coating.
 Torx tamper proof stainless steel hardware.

drawing number		
RAS-503		
drawing name		
GO-HOP		
3D VIEW		
date	scale	drawn by
11/09/21	NONE	D. Desilets eng.
ck. by		 <small>630, boul. Bécancour Bécancour (Québec) Canada G9H 3S7 phone: 819.298.3431 Fax: 819.298.2299 www.goelan.com</small>
APPEARANCE MAY VARY LIGHTLY FROM DRAWING		

CHILD CAPACITY : 23
 EQUIPMENT SIZE : 29' X 18' [8,9m X 5,5m]
 PLAY AREA : 41' X 30' [12,5m X 9,2m]
 FALL HEIGHT : 84"[214cm]

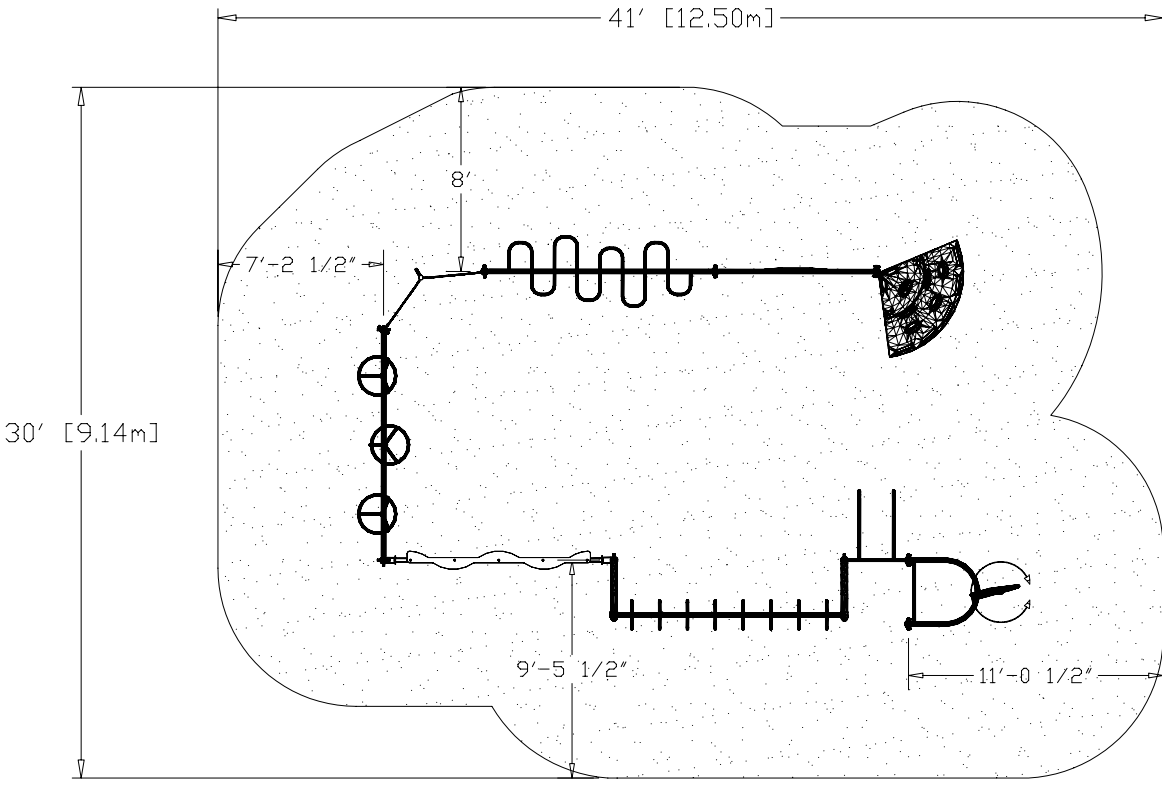

drawing number		
RAS-503		
drawing name		
GO-HOP		
PLAY AREA		
date	scale	drawn by
11/09/21	1=100	D. Désilets ing.
ck. by		 <small>630, boul. Bécancour Bécancour (Québec) Canada G9H 3S7 phone: 819.298.3431 Fax: 819.298.2299 www.goelan.com</small>
APPEARANCE MAY VARY LIGHTLY FROM DRAWING		